

OPTIONAL LID SHOWN  
(1942900M)

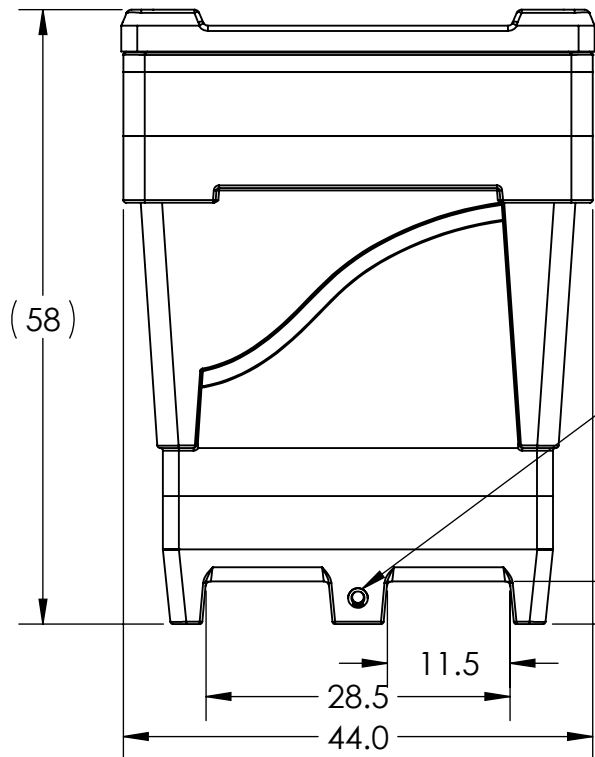
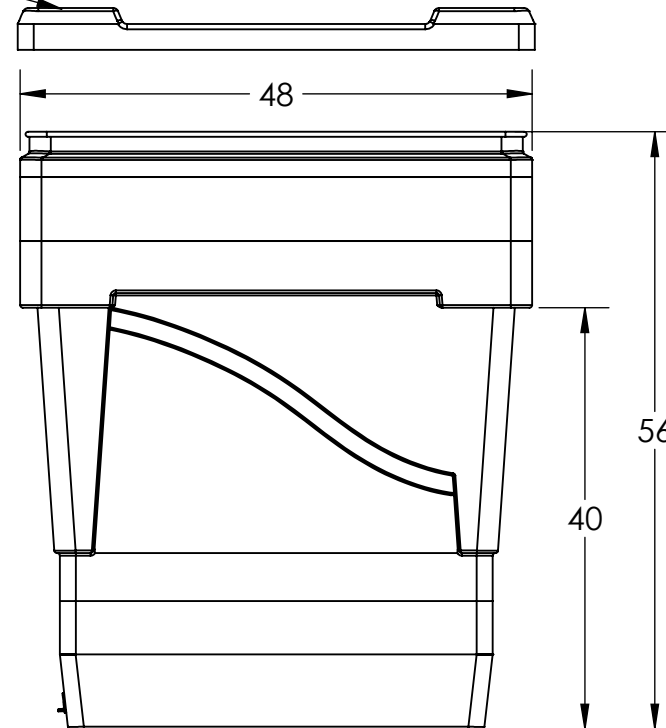

OPTIONAL DRAIN SHOWN  
(34500102)

ALL DIMENSIONS ARE IN INCHES, NOMINAL, & SUBJECT TO CHANGE WITHOUT NOTICE.  
ALL DIMENSIONS ON ROTATIONAL MOLDED PARTS ARE SUBJECT TO A  $\pm$  3% TOLERANCE.

DO NOT SCALE		DRAWN BY	BONAR PLASTICS www.bonarplastics.com	TITLE:	REVISION
STATUS:	Released	TJK	1005 Atlantic Drive West Chicago, IL 60185 (630)293-0303	<b>BIN 2056 ARMOR 2WY-MLD</b>	SHEET
© SNYDER INDUSTRIES INC., 2017			www.bonarplastics.com	PART NO.	1 OF 1
ALL DIMENSIONS, DESIGNS, AND INFORMATION ON THIS PRINT MUST BE CONSIDERED PROPRIETARY TO SNYDER INDUSTRIES, INC. AND MAY NOT BE USED, COPIED, OR DISTRIBUTED WITHOUT WRITTEN PERMISSION OF AN OFFICER (OR HIS AGENT) OF THE FIRM.			1944900M	ENG. ID.	D007199