

OPTIONAL LID SHOWN
(1942800M)

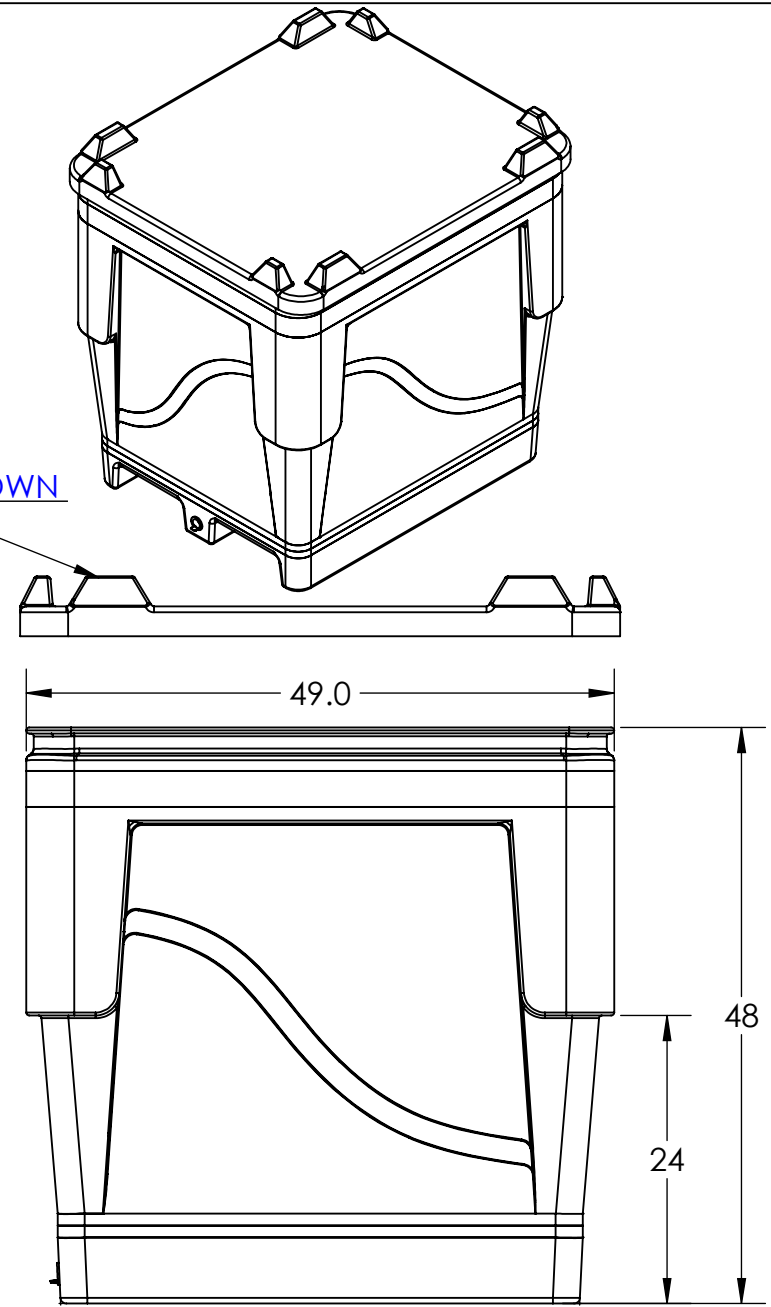

OPTIONAL DRAIN SHOWN
(34500102)

ALL DIMENSIONS ARE IN INCHES, NOMINAL, & SUBJECT TO CHANGE WITHOUT NOTICE.
ALL DIMENSIONS ON ROTATIONAL MOLDED PARTS ARE SUBJECT TO A \pm 3% TOLERANCE.

DO NOT SCALE		DRAWN BY	BONAR PLASTICS www.bonarplastics.com	TITLE:	REVISION
STATUS:	Released	TJK	1005 Atlantic Drive West Chicago, IL 60185 (630)293-0303	BIN 5048 ARMOR 2WY-MLD	A
© SNYDER INDUSTRIES INC., 2017			www.bonarplastics.com	PART NO.	SHEET
ALL DIMENSIONS, DESIGNS, AND INFORMATION ON THIS PRINT MUST BE CONSIDERED PROPRIETARY TO SNYDER INDUSTRIES, INC. AND MAY NOT BE USED, COPIED, OR DISTRIBUTED WITHOUT WRITTEN PERMISSION OF AN OFFICER (OR HIS AGENT) OF THE FIRM.				1946800M	1 OF 1
				ENG. ID.	D007090