

4WY BASE MAKES: 3039 ARMOR BIN
 RO BASE MAKES: 4039 ARMOR BIN

4WY ARMOR BASE (1949600M)

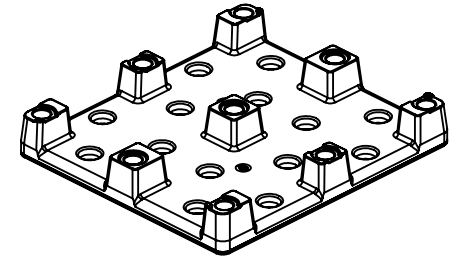

RO ARMOR BASE (1949700M)

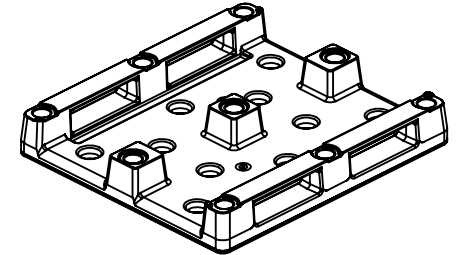

OPTIONAL LID SHOWN
 (1942900M)

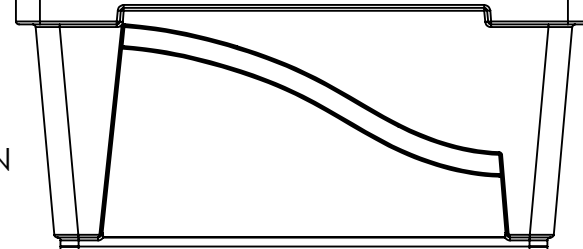
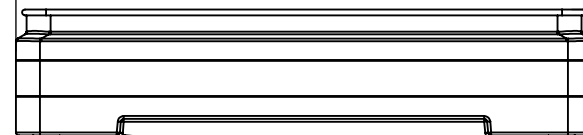
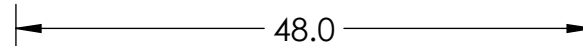
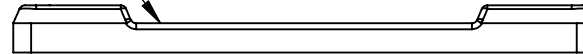

SHOWN WITH THE 4WY
 BASE

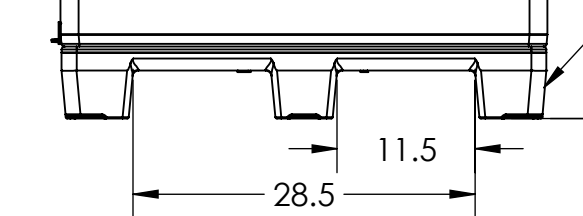
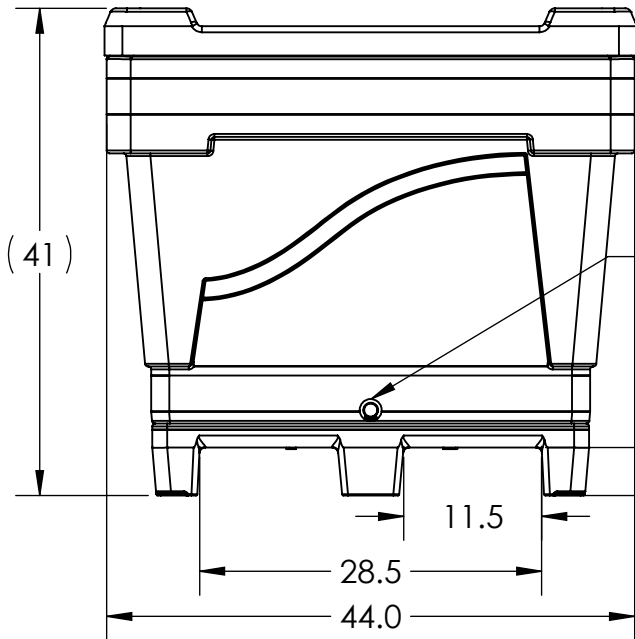

ALL DIMENSIONS ARE IN INCHES, NOMINAL, & SUBJECT TO CHANGE WITHOUT NOTICE.
 ALL DIMENSIONS ON ROTATIONAL MOLDED PARTS ARE SUBJECT TO A ± 3% TOLERANCE.

DO NOT SCALE		DRAWN BY	BONAR PLASTICS	TITLE:	REVISION
STATUS:	Released	TJK	www.bonarplastics.com	BIN 39TALL ARMOR	SHEET
© SNYDER INDUSTRIES INC., 2017		1005 Atlantic Drive West Chicago, IL 60185 (630)293-0303		PART NO.	1 OF 1
ALL DIMENSIONS, DESIGNS, AND INFORMATION ON THIS PRINT MUST BE CONSIDERED PROPRIETARY TO SNYDER INDUSTRIES, INC. AND MAY NOT BE USED, COPIED, OR DISTRIBUTED WITHOUT WRITTEN PERMISSION OF AN OFFICER (OR HIS AGENT) OF THE FIRM.		www.bonarplastics.com		1945400M	ENG. ID. D007023