

OPTIONAL LID SHOWN
(1925410M)

OPTIONAL DRAIN SHOWN
(34500102)

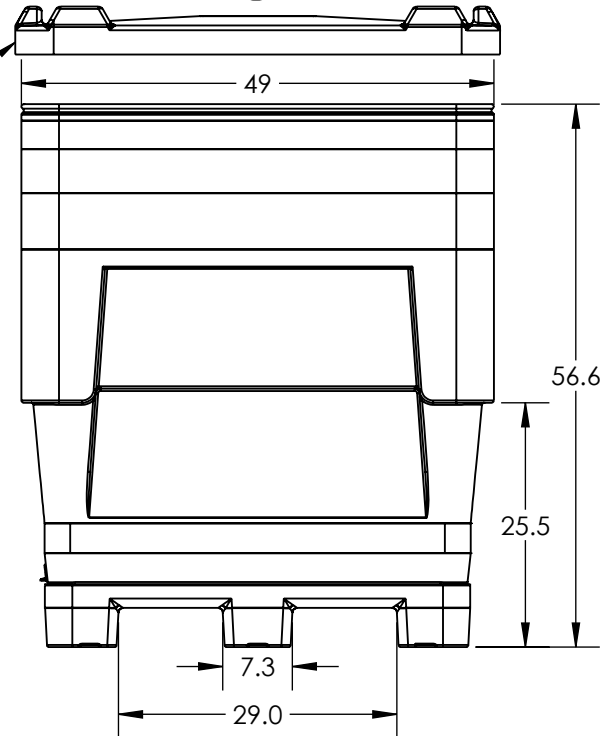

ALL DIMENSIONS ARE IN INCHES, NOMINAL, & SUBJECT TO CHANGE WITHOUT NOTICE.
ALL DIMENSIONS ON ROTATIONAL MOLDED PARTS ARE SUBJECT TO A \pm 3% TOLERANCE.

DO NOT SCALE		DRAWN BY	TITLE		REVISION
STATUS:	Released	KB	BONAR PLASTICS A BRAND OF TANK HOLDING CORP. 1005 Atlantic Drive West Chicago, IL 60185 (630)293-0303 www.bonarplastics.com		B
© TANK HOLDING, CORP, 2024			PART NO.		SHEET
ALL DIMENSIONS, DESIGNS, AND INFORMATION ON THIS PRINT MUST BE CONSIDERED PROPRIETARY TO TANK HOLDING, CORP. AND MAY NOT BE USED, COPIED, OR DISTRIBUTED WITHOUT WRITTEN PERMISSION OF AN OFFICER (OR HIS AGENT) OF THE FIRM.			1923910M		1 OF 1
			ENG. ID.		D002904