

OPTIONAL LID SHOWN
(1017100M)

MOLDED-IN
MONSTER COMBO
LOGO [1 LONG SIDE]

OPTIONAL DRAINS SHOWN
(34500102)

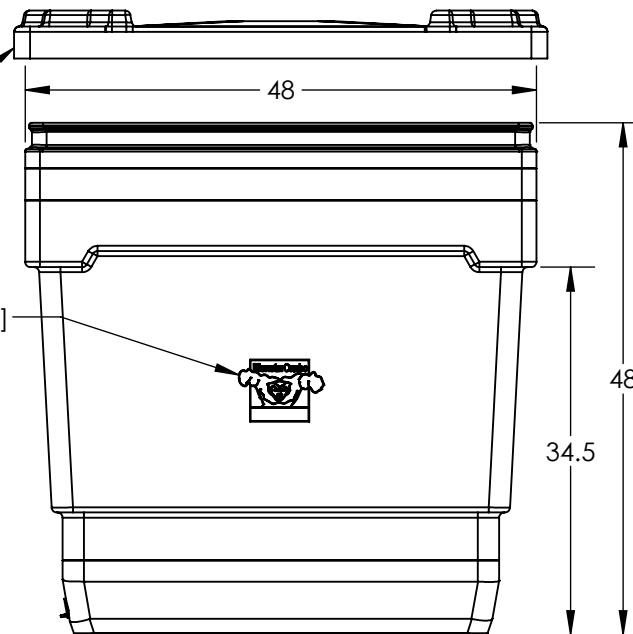

ALL DIMENSIONS ARE IN INCHES, NOMINAL, & SUBJECT TO CHANGE WITHOUT NOTICE.
ALL DIMENSIONS ON ROTATIONAL MOLDED PARTS ARE SUBJECT TO A \pm 3% TOLERANCE.

DO NOT SCALE		DRAWN BY	BONAR PLASTICS	TITLE:	REVISION
STATUS:	Released	KB	www.bonarplastics.com	BIN 2848 MONSTER CMBO 2WY WD WLID	B
© SNYDER INDUSTRIES INC., 2017		1005 Atlantic Drive West Chicago, IL 60185 (630)293-0303		PART NO.	SHEET
ALL DIMENSIONS, DESIGNS, AND INFORMATION ON THIS PRINT MUST BE CONSIDERED PROPRIETARY TO SNYDER INDUSTRIES, INC. AND MAY NOT BE USED, COPIED, OR DISTRIBUTED WITHOUT WRITTEN PERMISSION OF AN OFFICER (OR HIS AGENT) OF THE FIRM.		www.bonarplastics.com		1015700M	1 OF 1
				ENG. ID.	D002855